



safe work australia

Working with silica and silica containing products

National guidance material

SEPTEMBER 2019

Disclaimer

Safe Work Australia is an Australian Government statutory agency established in 2009. Safe Work Australia includes Members from the Commonwealth, and each state and territory, Members representing the interests of workers and Members representing the interests of employers.

Safe Work Australia works with the Commonwealth, state and territory governments to improve work health and safety and workers' compensation arrangements. Safe Work Australia is a national policy body, not a regulator of work health and safety. The Commonwealth, states and territories have responsibility for regulating and enforcing work health and safety laws in their jurisdiction.

ISBN 978-1-76051-831-8 (Online PDF)

ISBN 978-1-76051-832-5 (Online DOCX)

Creative Commons

With the exception of the Safe Work Australia logo, this copyright work is licensed under a Creative Commons Attribution 4.0 International licence. To view a copy of this licence, visit creativecommons.org/licenses In essence, you are free to copy, communicate and adapt the work for non-commercial purposes, as long as you attribute the work to Safe Work Australia and abide by the other licence terms.

Contact information

Safe Work Australia | <mailto:info@swa.gov.au> | www.swa.gov.au

Contents

Introduction	2
How to use this guide	5
Who has a duty?	6
PCBUs and officers.....	3
Workers	6
Manufacturers, designers, importers and suppliers	7
WHS laws in your state or territory	7
How to identify hazards and control risks to health and safety from exposure to silica dust	8
Consulting with workers	10
Identifying the hazard of silica dust.....	10
Assessing the risk	12
Air monitoring.....	15
Health monitoring.....	16
Choosing and implementing control measures for silica dust	17
Eliminating silica dust.....	17
Substitution	18
Isolate workers and others from silica dust.....	18
Engineering controls	19
Administrative controls	23
Personal protective equipment.....	27
Reviewing your controls	32
More information:	32

1. Introduction

If you are a person conducting a business or undertaking (PCBU) who has workers (including yourself) that work with silica or silica containing products this guide is for you. Silica containing products include:

- manufactured solid stone products such as composite (engineered) stone benchtops
- asphalt
- cement, mortar and grout
- concrete, concrete blocks and fibre cement products
- brick
- drywall and some plasterboards, and
- pavers and tiles including roof tiles.

This guide explains what you must do to keep your workers safe from the risks of [respirable crystalline silica \(silica dust\)](#).

Everything in this guide is covered by the model Work Health and Safety (WHS) laws.

2. How to use this guide

This guide will help you to understand and make decisions about protecting your workers from exposure to silica dust. It provides general information about controlling the risks of working with silica. It also provides more detailed information about controlling the risks of working with silica containing products that may contain very high levels of silica and pose a significant risk to the health of your workers.

We use 'must', 'requires' or 'mandatory' where duty holders have a legal obligation to comply with a requirement.

We use 'should' to recommend an action and 'may' where you can choose to do as we recommend.

3. Who has a duty?

[PCBUs](#), workers and other persons at the workplace have duties under the model WHS laws, including the duty to take reasonable care for their own health and safety at the workplace.

There are duties under the model WHS laws to control the risks of working with silica and [silica containing products](#) if you are:

- a PCBU at a workplace where silica dust is present, or an officer of that business or undertaking, or
- a designer, manufacturer, importer, supplier or installer of silica and silica-containing products.

A person can have more than one duty and more than one person can have the same duty at the same time.

A workplace includes any place where work is carried out and includes any place where a worker goes, or is likely to be, while at work. This may include offices, factories, shops, construction sites, vehicles or homes.

3.1. PCBUs and officers

If you have management or control over workers, you are likely to be a PCBU or an officer.

A [PCBU](#) can be a:

- company
- unincorporated body or association
- sole trader, or
- self-employed person.

Individuals who are in a partnership that is conducting a business will individually and collectively be a PCBU.

PCBUs have the primary duty of care for the health and safety of their workers and others at the workplace.

Officers, such as company directors, have a duty to exercise due diligence to ensure that the business or undertaking complies with the WHS laws. This includes making sure that the business or undertaking has and uses appropriate resources and processes to eliminate or minimise the risks of working with silica and silica containing products. This includes:

- identifying the hazard of silica dust
- controlling the risk of exposure to silica dust
- conducting air monitoring, and
- providing health monitoring for workers.

3.2. Workers

Workers have a duty to take reasonable care for their own health and safety and they must take reasonable care that their acts or omissions do not adversely affect the health and safety of other persons. Workers must:

- comply as far as they are reasonably able, with any work health and safety instructions from you as the PCBU, and
- co-operate with any reasonable policy or procedure relating to work health and safety that you as the PCBU put in place, including health monitoring, if they have been told about it beforehand.

Silica dust can cause serious illness and disease. Workers must participate in health monitoring and wear personal protective equipment (PPE) as instructed by a PCBU.

When discussing health and safety matters with workers, a consultative approach should be taken to allow workers a reasonable opportunity to express views before any decision is made. If a worker refuses to participate in health monitoring or refuses to use PPE as they have been trained and instructed, you as the PCBU may take action to meet your duties under the WHS laws. This could include removing the worker from the source of exposure.

3.3. Manufacturers, designers, importers and suppliers

Designers, manufacturers, importers and suppliers of silica containing products must ensure, so far as is reasonably practicable, that the plant or substance is without risks to health and safety. This duty includes carrying out testing and analysis of the product and providing specific information about the product. This information can be provided in the form of a label, product information sheet or a safety data sheet (SDS). Important information that must be provided includes:

- the amount of crystalline silica in the product
- the hazardous properties and risks to health of silica dust, and
- the health and safety precautions that must be taken when fabricating, installing, maintaining or removing silica containing products.

Suppliers of hired equipment (such as hand held water fed power tools or respiratory protective equipment) should take all reasonable steps to ensure appropriate information about the safe use of the equipment is available.

Manufacturers do not have a duty to provide safety data sheets (SDS) for solid products that contain silica, such as composite stone, brick or tiles. However, it is a good practice to make them available.

3.4. WHS laws in your state or territory

The Commonwealth, state and territory WHS regulators are responsible for enforcing the WHS laws. They make decisions about whether you are in compliance with the requirements.

The WHS laws are not exactly the same in each state and territory. If you need help please contact your [state or territory WHS regulator](#).

4. How to identify hazards and control risks to health and safety from exposure to silica dust

Silica is silicon dioxide. It is naturally occurring and found in many rocks and soils. There are non-crystalline and crystalline forms of silicon dioxide. The most common type of crystalline silica is quartz (CAS 14808-60-7).

Exposure to silica dust can result in:

- illness and disease
 - for example sarcoidosis, breathing problems, chronic bronchitis, emphysema, lung cancer, progressive massive fibrosis and [silicosis](#), and
- injury
 - for example eye irritation and eye damage.

There are three types of silicosis—acute, chronic and accelerated. Silicosis and progressive massive fibrosis are irreversible and often fatal. Symptoms of these diseases may not appear for many years after exposure. Workers may be diagnosed with these diseases and not present with any symptoms, even at the point of initial diagnosis, which is why prevention and health monitoring are critical.

As the duty holder, you will need to implement a combination of different control measures to eliminate or minimise generating silica dust at your workplace. This includes when working with naturally occurring silica (for example in mining or tunnelling) or working with products containing high amounts of silica (such as composite stone).

If you rely solely on one control measure, such as PPE, there may be a significant risk to your worker's health and you may be breaching WHS laws. It has been shown that solely relying on PPE does not adequately protect your workers.

This guide is only intended to provide guidance about how you can control the risks of silica dust. It does not cover every hazard that may be present at your workplace. You must be careful to make sure that when you are controlling silica dust that you are not introducing other hazards or not fulfilling your WHS duties for other hazards.

You can manage [risks](#) of exposure to silica dust by selecting and implementing measures using the [hierarchy of controls](#).

Figure 1 The hierarchy of control measures

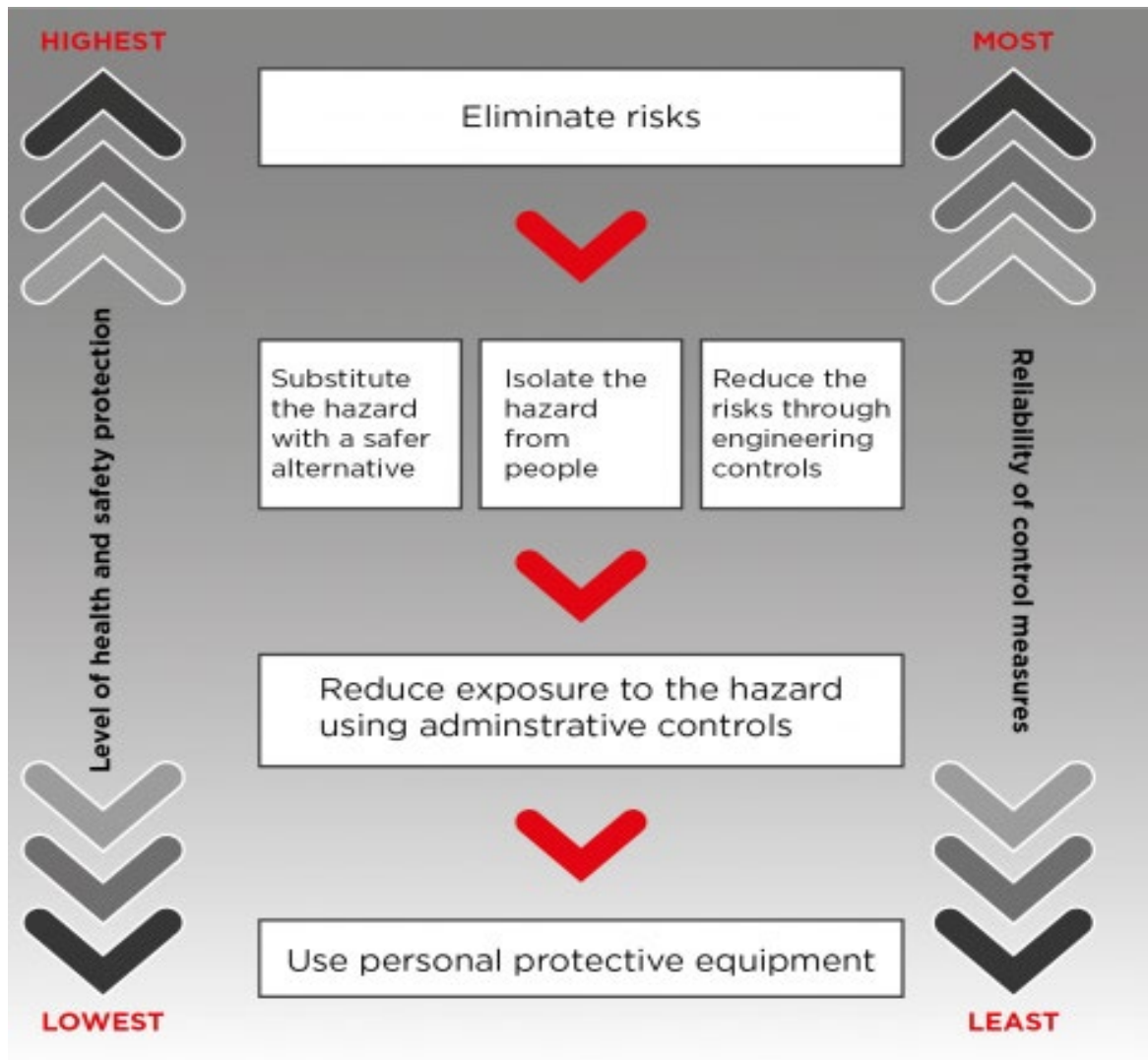

4.1. Consulting with workers

You must talk with your workers and their elected Health and Safety Representative (HSR) (if represented) about health and safety at your workplace. This includes talking about all matters relating to silica dust.

Workers must be consulted on health and safety matters including (but not limited to):

- identifying risks of silica dust exposure
- developing a silica dust control plan
- making changes to processes or procedures that generate silica dust
- improving controls put in place to protect workers from silica dust
- resolving health and safety issues
- health monitoring
- monitoring the conditions at the workplace, and
- providing information and training for workers.

Participation of your workers in discussions about health and safety is important, as they are most likely to know about the risks of their work. Joint involvement in identifying hazards and assessing and controlling workplace risks will help build worker commitment to this process and any changes that may result.

The model [Code of Practice: Work health and safety consultation, cooperation and coordination](#) can give you more information about your duties to consult.

4.2. Identifying the hazard of silica dust

To manage risks of silica dust, you must first identify whether silica dust is being generated and released into the air at your workplace. Workers are exposed to silica dust whenever it is airborne and they can breathe it in.

Different types of rock and rock products can contain different amounts of silica, for example:

Type	Amount of silica (%)
Granite	25 to 40
Shale	22
Natural sandstone	67
Composite stone	> 90
Aggregates, mortar and concrete	various

Silica dust is generated in workplace processes such as crushing, cutting, drilling, grinding, sanding, sawing or polishing of natural stone or man-made silica containing products. Silica dust can be generated and found:

- during manufacturing and construction
- when mining or tunnelling
- in waste or sand-based products, and
- in materials brought to your workplace.

Some dust particles can be so small that they are not visible; these are referred to as respirable particles. Respirable silica dust particles are those that are small enough to breathe in and penetrate deep into the lungs causing permanent damage that can lead to

serious illness or death. Silica dust is also linked to the development of auto-immune disorders and chronic renal (kidney) disease.

A label or safety data sheet (SDS) may not always be available at a workplace or with a product that contains silica. If you do not have an information sheet or SDS for a product, you might need to talk to your supplier to find out how much silica is present. However, you can assume that all composite stone products contain very high amounts of silica.

Common silica containing materials and products include:

- stone products (natural and composite)
- composite dental fillings
- manufactured timber
- bricks
- cement
- asphalt
- drywall and some plasterboards
- grout
- mortar
- tiles, and
- even some plastic material.

Activities that release silica dust into the air include:

- fabrication, installation, maintenance and removal of composite stone countertops
- excavation, earth moving and drilling plant operations
- clay and stone processing machine operations
- paving and surfacing
- mining, quarrying and mineral ore treating processes
- road construction and tunnelling
- construction labouring and demolition
- brick, concrete or stone cutting; especially using dry methods
- abrasive blasting (blasting agent must not contain greater than 1 per cent of crystalline silica)
- foundry casting
- angle grinding, jack hammering and chiselling of concrete or masonry
- hydraulic fracturing of gas and oil wells
- pottery
- crushing, loading, hauling and dumping of rock or muck, and
- clean-up activities such as sweeping or pressurised air blowing of dust.

EXAMPLES OF WORK WITH POTENTIALLY HARMFUL EXPOSURES TO SILICA DUST

Manufacturing silica containing products

The use of composite stone materials for benchtops in domestic and commercial premises has significantly increased in the last 10-15 years. Manufacturing stone items can result in a risk of dust exposure.

Fabricating, installing, maintaining and removing silica containing products

Silica dust can be made when cutting, grinding, trimming, removing or blasting silica containing products or from storing or disposing of dusty waste from these processes.

Composite stone products can contain up to 97 per cent silica. The high amount of silica means that there is a very high risk of workers developing breathing problems and silicosis if they breathe in dust made from these products. An increase in the number of workers diagnosed with silicosis and progressive massive fibrosis has been linked to working with composite stone.

Mining, quarrying, tunnelling and extractive minerals

Exposure to silica dust is a known issue, with high risks of worker exposure during rock crushing activities.

Construction, building and demolition

Silica dust can be formed on site from concrete cutting and using power tools on stone.

4.3. Assessing the risk

A risk assessment involves considering what could happen if your workers are exposed to a hazard and the likelihood of it happening.

If you have identified silica dust at your workplace or identified that it may be generated as part of your work practices, you should consider:

- how, where and for how long workers could be exposed to silica dust
- the control measures you have in place to control the dust, and
- the ways you can measure how well your control measures work.

Respirable silica dust is invisible to the naked eye and can hang in the air for a very long time after work has finished. Larger, visible dust particles settle long before invisible dust particles do, meaning workers can breathe in respirable dust even if they cannot see it in the air. It is important to consider whether workers (and other people in the workplace not working directly with silica) are at risk of exposure.

Respirable crystalline silica particles are less than 10 microns (μm) in diameter and when breathed in can reach deep into the lungs (see figure 2 below).

Figure 2 Dust particle sizes (from Mining and Quarrying Occupational Health and Safety Committee)

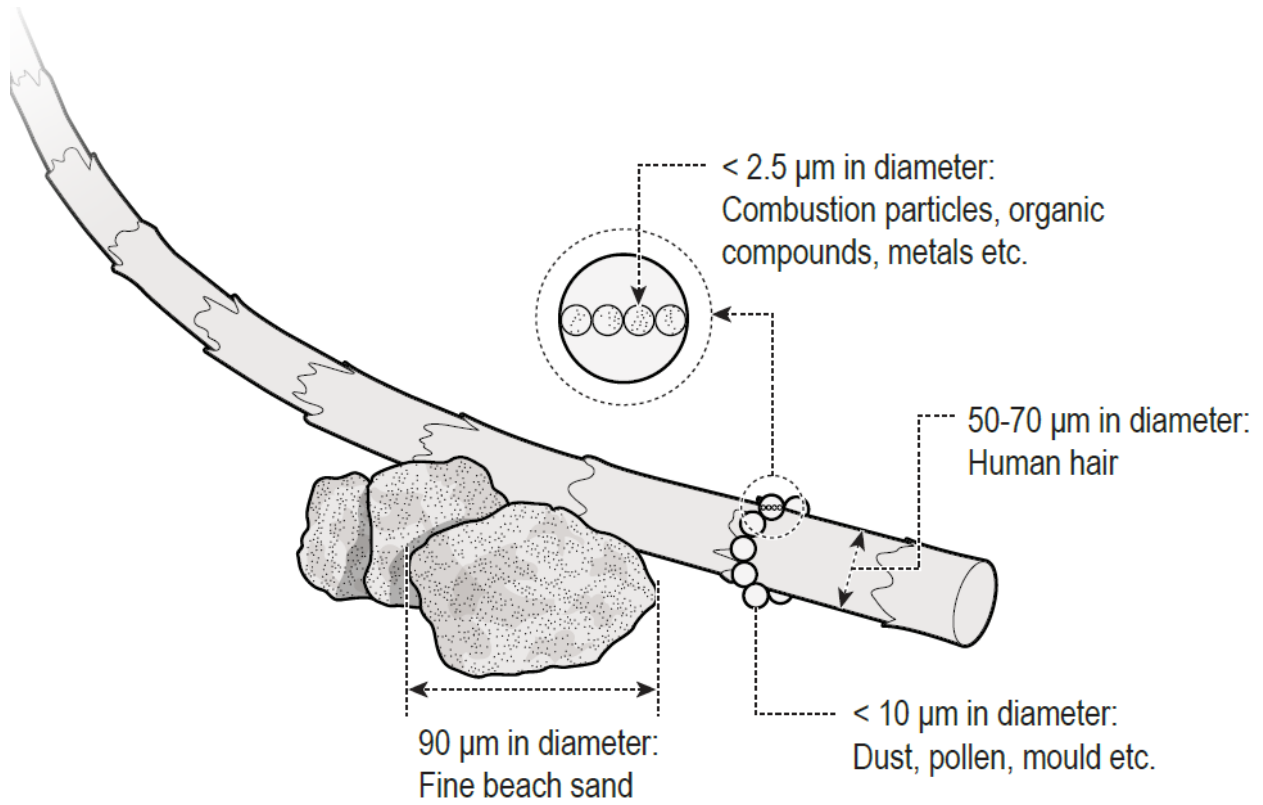

When assessing risk, you should consider if there are other airborne contaminants (fumes or mists) that workers could also be exposed to. It is important to consider if the control measures you have protect your workers from all possible exposures.

EXAMPLE RISK ASSESSMENT Q & A: XYZ PAVING COMPANY

You own a small business that cuts and lays paving stones that contain silica.

Most cutting of paving stones is done outdoors using hand-held power tools. Cutting with a saw is normally carried out with a diamond blade, water suppression and on site. Block splitters are rarely used.

Very fine sand is also used when finishing laying stones. It is dry swept between the paving stones.

What is the hazard?

Workers can breathe in silica dust when cutting paving stones and when sweeping sand.

What is the harm?

Lung damage including cancer, bronchitis and silicosis.

Who may be harmed?

All workers undertaking cutting and sweeping tasks and workers and other people nearby.

What are you doing now?

- PPE for safety (steel-toe boots, protective work wear, hard hats, gloves)
- water to suppress dust

- cutting is done close to where pavers are laid
- some hoses are leaking and some attachments are broken
- slurry is not collected
- sand is dry swept
- goggles to protect worker's eyes
 - some are very old
- dust masks
 - some workers have beards and don't put them on
- hearing protection (ear plugs) for loud power tools
 - workers nearby cutting don't have ear plugs

What actions and improvements do you need?

- Designate cutting area further from where paving stones are laid to minimise dust and noise exposure to other workers
- Use wet methods to clean up and finish laying stones
- Check and repair water connections and hoses
- Collect slurry in a pan under the saw for disposal
- Implement maintenance schedule for equipment and PPE
- Provide PPE and RPE training for workers
- Review type of dust masks required for tasks
- Review clean shaven policy
- Replace old and faulty goggles
- Provide hearing protection to workers nearby cutting area

If your workers are cutting, grinding, sanding, drilling and polishing silica containing products or carrying out any activities that release silica dust into the air, then there is a significant risk that without effective controls they will be exposed to respirable silica dust and develop an illness or disease.

If your workplace has any work practices that generate dust from composite stone products, there is a significant risk to the health of your workers and others.

Some tools release more silica dust into the air than others. Workers who use hand tools to cut or grind composite stone (such as circular saws or grinders) can have some of the highest exposures to silica dust. These tools are often used to complete fabrication and installation tasks including cutting holes for sinks and stove tops or during shaping and joining.

In areas where hand tools are used, workers performing other tasks may also be exposed to high levels of dust.

Dry cutting, grinding or polishing composite stone without water suppression and local exhaust ventilation generates very high levels of silica dust that far exceed the [workplace exposure standard](#).

Many WHS regulators have now banned uncontrolled dry cutting of composite stone due to the extreme risk that this practice poses to worker health. Please check with your local WHS regulator if this applies to you.

For further information about how to manage WHS risks, refer to the [model Code of Practice: How to manage work health and safety risks](#). The [model Code of Practice: Managing the risks of hazardous chemicals in the workplace](#) also has information about how to conduct a detailed risk assessment for chemicals (including silica dust) at the workplace.

In Queensland, if you are installing a composite stone benchtop you will need to prepare a safe work method statement (SWMS). For more information, refer to the [model Code of Practice: Construction work](#).

Air monitoring

There is a [workplace exposure standard](#) for respirable crystalline silica that must not be exceeded. The workplace exposure standard in Australia is 0.1 mg/m³.

The workplace exposure standard for silica is under review. More information can be found on the [workplace exposure standards page](#).

You must do air monitoring to determine the airborne concentration of respirable crystalline silica at your workplace if:

- you are not certain if you are exceeding the exposure standard, or
- monitoring is necessary to find out if there is a risk to health.

Air monitoring can help in assessing the risk to your workers because it can show:

- how much your workers are being exposed
- which processes or products are the source of the exposure, and
- if your current control measures are working.

Figure 3 Worker's breathing zone



A competent person should conduct your air monitoring, for example a Certified Occupational Hygienist.

You must keep records of air monitoring for at least 30 years. You must also make sure that your workers can access these records. An air monitoring report should include:

- the background and purpose of the air monitoring including the current workplace exposure standard
- the task to be measured including work patterns and hazards involved with this task
- the control measures in place and their performance
- what sampling and measurements were taken (long and short-term) including information on the calibration of the sampling equipment
- specifics of how sampling was taken
- how and where the samples were analysed including information on the calibration of the analysis equipment
- an interpretation of the results:
 - exposure sources
 - adequacy of current control measures
 - assessment of risk including identification of tasks not measured that are likely to be an exposure source and any workers that could be exposed but were not measured, and
 - compliance with WHS laws
- recommendations, for example:
 - dust control action plan
 - changing control measures and work practices
 - worker training
 - further air monitoring, and
 - health monitoring.

AIR MONITORING AT WORKPLACES THAT WORK WITH SILICA CONTAINING PRODUCTS

There is insufficient evidence to show that any one combination of controls is guaranteed to keep exposure below the workplace exposure standard when working with silica containing products such as composite stone.

When working with silica containing products, air monitoring will be needed to confirm whether the exposure standard for respirable crystalline silica is being exceeded.

It is recommended that air monitoring is carried out:

- at least once a year if you work with silica containing products
- if a worker becomes unwell or if a health monitoring report recommends you review your control measures
- if your work practices or the types of tools used change
 - for example you use a new tool more often, and
- if new control measures are implemented or you change your control measures
 - for example if you install an isolation booth or ventilation, or apply a new shift rotation.

Health monitoring

If there is a risk to the health of your workers because of exposure to silica dust, you must organise and pay for health monitoring. This includes workers who are not directly generating dust but may be in the vicinity of silica dust or in contact with silica dust in other ways such as through cleaning work areas or equipment.

Some silica containing products, such as composite stone, contain very high levels of silica and are considered to pose a significant risk to the health of workers that work with them. Under the WHS laws, this means you must provide and pay for health monitoring for all

workers involved in fabrication or installation of composite stone products. You should also consider providing health monitoring to other workers who might be exposed to dust from these processes. This includes workers who are exposed to dust while cleaning or those who perform administrative work in the vicinity of fabricating products containing high levels of silica. Workers that should be provided health monitoring include:

- shapers
- saw operators
- finishers
- CNC router and water jet operators
- polishers
- labourers, and
- supervisors.

Health monitoring should begin at the time a worker is first employed or when they first start working with silica and silica containing products. This is so any changes to the worker's health can be detected. If your workers have been working with silica, especially with composite stone products and you have not provided health monitoring, you must organise it as soon as possible.

Health monitoring must be carried out or supervised by a doctor with experience. Health monitoring for silica dust includes workers being screened with specialised equipment. Depending on the worker's past exposures and medical history, some doctors may recommend carrying out further tests with a specialist in order to detect early stage silicosis.

The doctor doing your health monitoring will provide you with a health monitoring report. They must be kept for at least 30 years and the worker must receive a copy of the report.

You must provide the health monitoring report to your WHS regulator if the doctor doing your monitoring:

- **informs you that a worker may have contracted a disease, injury or illness as a result of carrying out work using, handling, generating or storing silica, or**
- **recommends that you take remedial measures (such as removing a worker from work).**

In some jurisdictions, the doctor may notify a worker's disease diagnosis to the Department of Health.

If you are a PCBU that provides health monitoring, particularly if you share your duties with another duty holder, please seek further information from the *health monitoring guide for PCBUs and health monitoring guide [for crystalline silica](#)*.

4.4. Choosing and implementing control measures for silica dust

The control measures that are the most effective for your workplace will depend on your industry, work processes and the risk of exposure.

It is most likely you will need to use a range of control measures to protect your workers from exposure to silica dust. You will also likely need air monitoring and health monitoring programs to confirm your control measures are working and your workers are protected.

Eliminating silica dust

Elimination means you completely remove the hazard from your workplace.

In many cases, eliminating silica dust is not practicable. Elimination may not be possible if silica dust is naturally occurring at your workplace or you can't make the end product or deliver a service without generating it.

You can eliminate silica dust at the source by eliminating the processes that generate dust. For example:

- adopting production processes that generate less dust
 - for example any wet method is likely to generate less dust than a dry one
- treating the dust at the point of generation, as this is more effective than capturing airborne dust, and
- treating the dust on its transmission path using dust suppression techniques
 - for example water sprays, chemical additives, local exhaust ventilation (LEV), vacuum.

If it is reasonably practicable, eliminate the silica containing products from your workplace. This will effectively remove the risk of workers being exposed to silica dust when working with these products.

Substitution

Substitution is where you replace a product or chemical with something that is less hazardous and therefore has a lower risk.

Effective substitution of silica and silica containing products will depend on your workplace and the work tasks your workers carry out. Again, substitution might not be practicable where silica is naturally occurring or if it means you can't make the end product or deliver a service.

Substitution can be an effective way of managing the risk of exposure to silica dust. For example, you can:

- use products that do not contain silica or have less silica in them
- use a silica containing product that does not need to be cut, ground or polished, and
- use a liquid or paste form of a silica product.

Isolate workers and others from silica dust

Isolation is where you place barriers or distance between a hazard and your workers.

Isolation is an effective way of protecting your workers from exposure to silica dust. Physical barriers that remove the worker from contact with silica dust are the most effective form of isolation controls.

Isolation controls include:

- isolating high dust generation work processes within an enclosed room with restricted access
- providing physical barriers and exclusion zones between different workers and workstations to prevent dust or water mist from moving into other work areas or towards other workers
- distancing a work process from other workers.
 - for example consider where other workers are working when powered hand tools are used
- designating a room or area for other tasks such as changing or eating, away from the work area.

You can also use barriers around automated tasks to shield workers from silica dust.

Wherever possible, workers should not fabricate silica containing products at the installation site. If modifications at the installation site need to be made, this work should be done outdoors in a designated area, wearing appropriate PPE and using engineering controls, including wet methods and dust collection systems.

Figure 4 An example of an isolation booth used for automated wet cutting

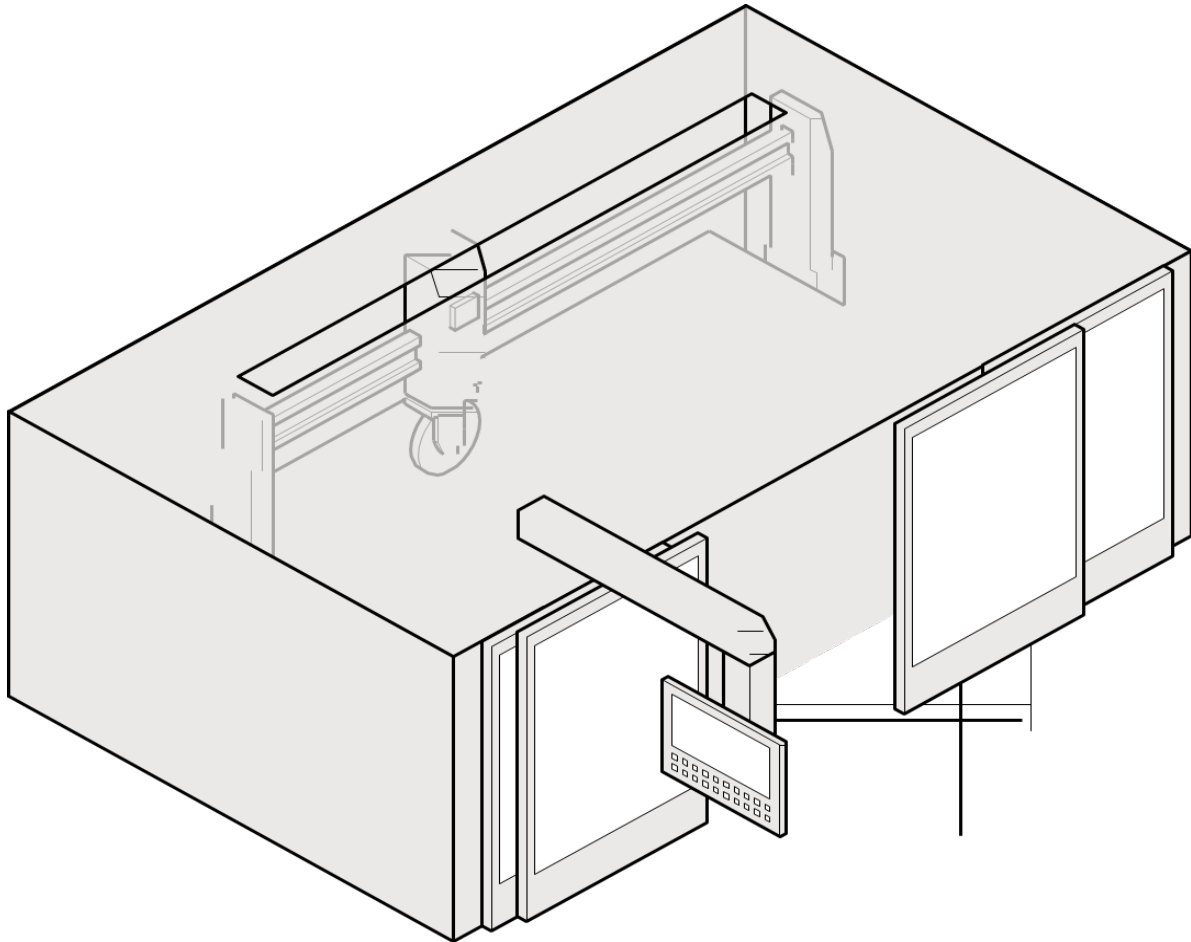

Engineering controls

Engineering controls use physical methods to change the characteristics of a task. The best engineering controls for your workplace will depend on the tasks your workers carry out.

Engineering controls to control silica dust include:

- automation when cutting, grinding or drilling
- using wet cutting methods
- local exhaust ventilation
- drills, routers, saws and other equipment designed to be fitted with H-class local exhaust ventilation and a water attachment to suppress dust
- using sacrificial backer-boards or spoil boards
- fitting large machinery such as excavators and bulldozers with positive pressure enclosed cabs, and
- cleaning up dust with a M or H-class industrial vacuum cleaner.

When considering and using engineering controls, be aware of other hazards that may be introduced. As many engineering controls are motorised you should be aware of noise and vibration levels at your workplace and issue personal hearing protection as needed.

Silica dust is abrasive and can damage and wear engineering controls. It is important to have a maintenance schedule in place to keep your equipment in good working order. You should regularly inspect your equipment for:

- wear and tear, corrosion or damaged parts
- air leaks in pneumatic tools
- kinks, holes or leaks in water suppression or dust extraction equipment, or
- damage to guards and flaps that contain water spray.

Ventilation

Ventilation is a very effective engineering control when designed correctly. There are a range of different ventilation systems and you need to use the ones that suit your workplace and the tasks your workers carry out.

Figure 5 A worker cutting/grinding with on tool dust extraction



Local exhaust ventilation

Local exhaust ventilation can be used to remove silica dust close to the source before it reaches the breathing zone of a worker.

More information about ventilation and other engineering controls can be found in the [model Code of Practice: Managing risks of hazardous chemicals in the workplace.](#)

Figure 6 Operational view of local exhaust ventilation

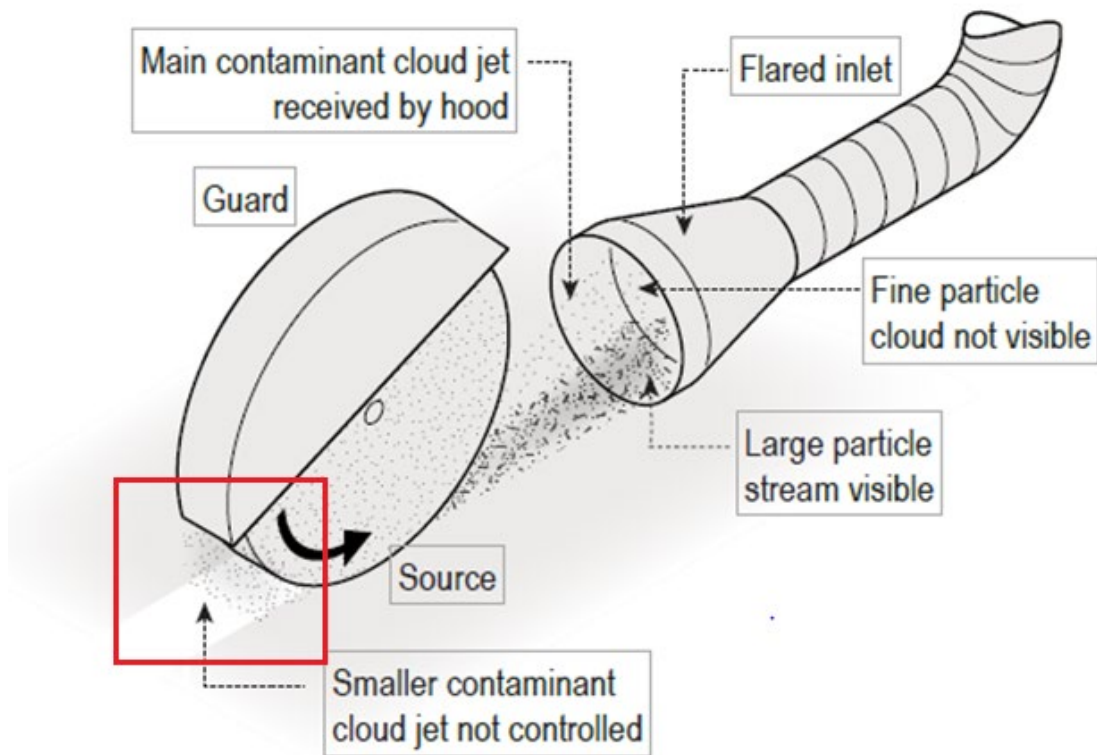

Engineering controls for silica containing products

Research has found that even when wet methods are used on products that contain high levels of silica that silica dust is not adequately controlled. Applying water to rotating tools can also generate silica contaminated mist that must also be controlled.

Figure 7 Examples of using local exhaust ventilation

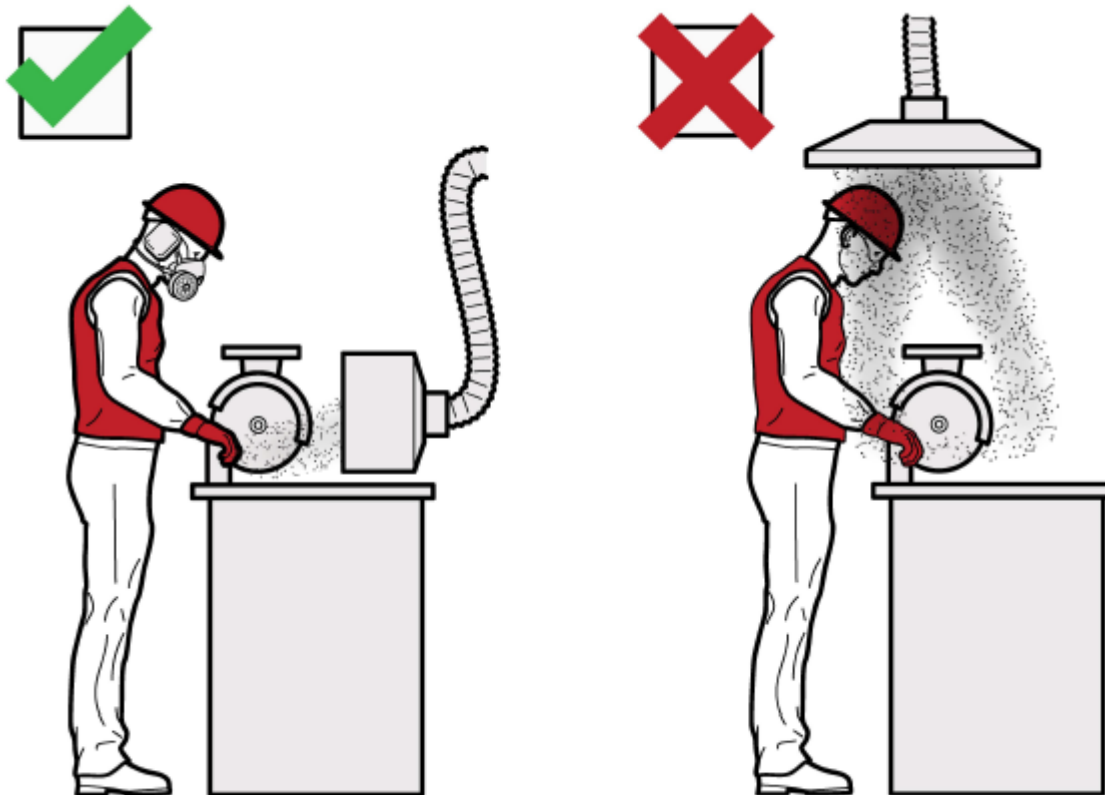

For this reason, properly designed water suppression and local exhaust ventilation should be used in combination when working with these products. It is important to:

- only use tools and machinery that have been specifically designed for use with water attachments with the appropriate ingress protection (IP), for example:
 - when cutting slabs, use bridge saws fitted with water attachments to suppress dust
 - to complete sink and stovetop cut outs, use water suppressed routers, water jet cutters or bridge saws
 - use hand-held angle grinders fitted with multiple water feeds that deliver water to the cutting disc and the point of contact with the stone
 - use water suppressed wet-edge milling machines or polishing machines
 - when polishing or grinding stone, use polishers with a centre water feed
- use an adequate number of water feeds to prevent visible dust during the process
- maintain adequate water pressure (0.5 L/min or as specified by the manufacturer) to make sure water is reaching the product or tool
- control water spray using guards, plastic flaps or brush guards
- prevent workers from being able to turn water suppression systems down or off during operation
- only use tools and machinery that have been specifically designed for local exhaust ventilation attachments such as drills, circular saws and grinders equipped with a shroud and a h class rated vacuum, and
- install fixed, portable or flexible capturing hoods to capture dust at the point of generation.

The use of a handheld spray bottle, sponge or garden hose to separately apply water to rotating tools is inadequate to suppress silica dust.

Wet methods of fabrication can introduce other hazards to your workplace. When using wet methods consider:

- installing ventilation to control water mist that may carry dust
- providing waterproof aprons, waterproof, non-slip footwear and eye protection that does not fog up and obstruct worker's vision
- filtering water that is recycled
- ensuring run-off is effectively drained away from equipment and work areas
- installing non-slip flooring
- implementing housekeeping policies to make sure run-off does not dry to create a dust hazard, and
- if you are working outside with wet methods and it is very cold, check for ice hazards.

Figure 8 Example of wet cutting method and suitable PPE

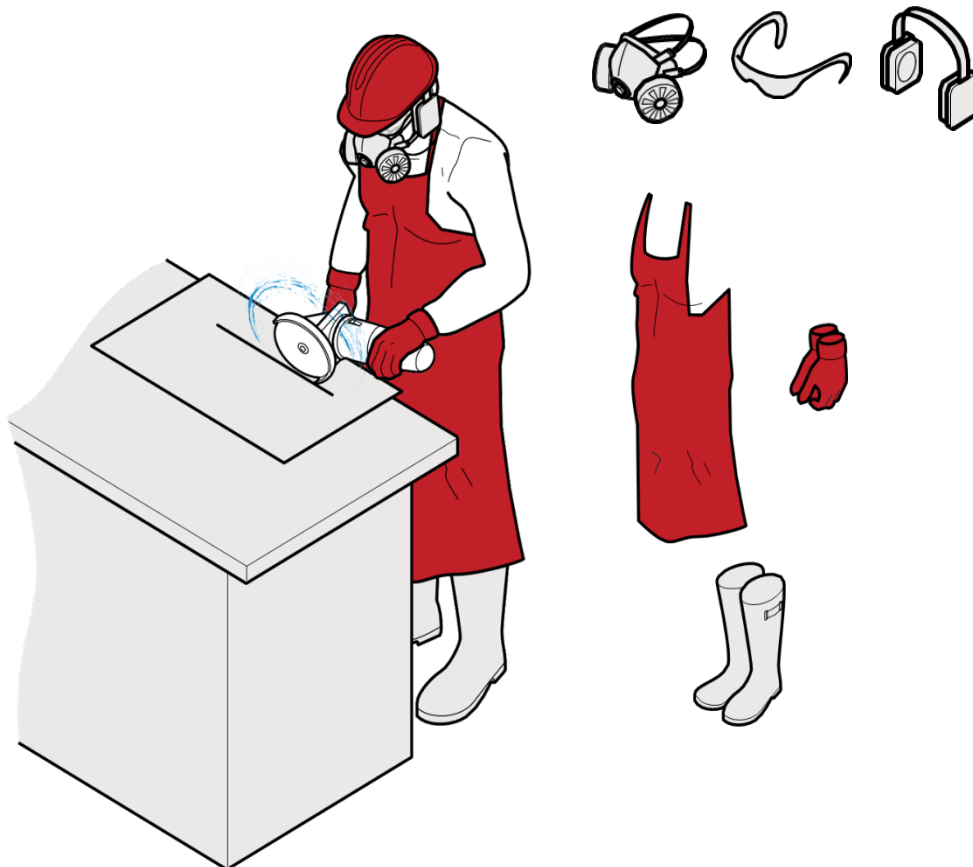

Administrative controls

Administrative controls should only be used to provide additional protection and must only be considered after implementing substitution, isolation and engineering controls.

Administrative controls rely on worker behaviour and it is very important to have administrative policies and worker training when silica is identified at your workplace. You also need to supervise your workers to make sure they understand and follow your administrative policies.

Examples of administrative controls for silica dust include:

- planning cutting tasks to make sure the minimum number of cuts are made
- written rules and policies for working with silica or cleaning silica waste
 - for example having a written clean-up procedure and log
- a maintenance schedule and log for equipment and PPE
- a job rotation schedule so that the same workers are not continually exposed to silica, and
- restricted area policies so that only staff who are carrying out a task that generates silica dust are allowed access to high risk areas.

Administrative controls when working with silica containing products

If you work with silica containing products, you should develop and implement administrative controls to support the higher level control measures you have in place to protect your workers. These may include:

- shift rotation policies to make sure workers are not exposed to dust above the workplace exposure standard and for extended periods of time
- providing a laundry service for dusty PPE and work wear supported by a policy outlining:
 - that dusty PPE and work wear are not to be taken home
 - designated areas where dusty PPE and clothes must be changed
 - when dusty PPE and clothes must be laundered
- policies for storage, cleaning and maintenance of equipment and PPE that require:
 - dusty PPE and equipment to be stored in sealed bags when not in use
 - cleaning of PPE and equipment to be done in designated areas only, and
 - signage at the workplace highlighting there is a dust hazard and any use of RPE and PPE.

Figure 9 Examples of dust hazard signs



Training

When you are working with silica or silica containing products, you must talk to your workers about silica dust hazards. Training must be provided:

- as part of induction and refresher training
- when a worker will be carrying out a particular task or activity where silica dust is present or could be generated, and

- when significant changes are made at the workplace that change how workers might be exposed.

The information you give to workers during training should give them a good understanding of:

- what silica dust is and health effects
- what controls are in place to protect them
- when they might be at risk of exposure including
 - bad work practices, or
 - when controls might not be effective, and
- what to do if they observe unsafe practices at the workplace.

You should encourage your workers to report hazards and health and safety problems immediately. This is important because it allows the risks to be managed before an incident or illness occurs.

Housekeeping

Good housekeeping can eliminate or reduce exposure to silica dust, even after work has stopped. Developing written rules and policies for your workplace is a good way to implement housekeeping as an administrative control. For example you could require your workers to:

- wet down dusty work areas and processes
- conduct a cleaning schedule for work areas and a maintenance schedule for engineering controls
 - for example regularly cleaning dusty vehicle track or high use areas and keep them wet during the day
- carry out daily cleaning procedures for slurry and settled dust
 - for example placing wet slurry inside a sealed container for disposal
- never use compressed air, dry sweeping or general purpose vacuum cleaners to clean surfaces or clothing
- use a low pressure water, wet sweeping or a M or H class rated vacuum cleaner to clean dusty floors, walls, other surfaces and equipment, and
- always follow the vacuum manufacturer's operator manuals and instructions for changing dust bags and filters.

If your workers are outdoors, you can cover the ground with plastic sheeting and remove remaining dust using the above methods.

Decontamination

Dusty clothing and PPE can expose workers and others to silica dust. Examples of how you can minimise exposure to dust carried on PPE and work clothes include:

- using an industrial H class vacuum cleaner to remove dust from clothes and uniforms
 - by positioning these units at the exits of dusty work areas, you can encourage workers to vacuum their clothes before leaving
 - you should make sure that workers have access to an area to wash their arms, hands, faces and even their hair.
- *providing a laundry service for dusty work clothes and PPE so they are not taken home for washing*
 - if you use a commercial laundry, dampen the clothes and place them in a sealed, labelled plastic bag, and inform the laundry that the clothes are contaminated with crystalline silica
- *requiring* workers to change dusty clothing after each shift, or if they have just finished a very dusty task to change at their next break, and
- providing workers with rubber boots and aprons.

Worker's clothes and uniforms must be cleaned frequently to stop silica dust from contaminating break rooms, other parts of the workplace and importantly, to stop workers from taking silica dust home.

More information about facilities at your workplace can be found in the [model Code of Practice: Managing the work environment and facilities](#).

Personal protective equipment

You should never rely solely on PPE to protect workers from silica dust.

Before using PPE you need to do a risk assessment to see what other controls can and should be used. PPE should only be considered after implementing substitution, isolation, engineering and administrative controls. It should only be used to supplement higher-level control measures or when no other safety measures are available.

There are requirements under the WHS laws when it comes to choosing and using PPE.

You must make sure the PPE you provide is appropriate (check the SDS if one is provided) and fits the worker who will be wearing it. This will ensure that the PPE is doing its job. Wrong or ill-fitting PPE means that silica dust can harm your workers. For example the dust can get into worker's eyes or into the worker's breathing zone and into their lungs.

You must make sure PPE is clean, hygienic and in good working order. This is so that you do not introduce other hazards to the worker and that the PPE will work as intended. Information about maintaining and cleaning PPE should be sourced from the manufacturer or supplier.

You must provide ongoing training, information and instructions for your workers on how to use, clean and store the PPE you provide. Workers must take reasonable care for their own health and safety. They are expected to follow reasonable instructions and cooperate with any workplace policies you have in place to protect them. Workers must use and wear PPE as instructed by you. However, you must also supervise your workers to check they understand their training and are using the PPE correctly.

Figure 10 Personal protective equipment



Respiratory protective equipment

As silica dust particles are very small, workers should use a tight-fitting respirator with an effective face seal. This means they need to be clean-shaven or only have facial hair that does not interfere with the fitting surfaces or the respirator valve. As everyone's face is a different size and shape, there is no 'one size fits all' tight-fitting respirator. This means that you should also fit test each worker and their RPE before they undertake dusty work.

For workers who want to keep facial hair that may interfere with the operation or proper fit of tight-fitting respirator (for example a closely trimmed beard), a powered air purifying respirator with a loose hood may be suitable.

FIT TESTING RESPIRATORY PROTECTIVE EQUIPMENT

Fit testing measures the effectiveness of the seal between the respirator and the wearer's face.

Workers should pass a respirator fit test before they first start wearing a tight-fitting respirator including:

- half face disposable
- half face reusable
- full face reusable, and

-
- tight-fitting powered air purifying respirators (PAPR).

There are two types of fit testing that can be carried out:

- Qualitative
 - a pass/fail test that relies on the wearer's ability to taste or smell a test agent
 - only used on half face respirators, and
- Quantitative
 - uses specialised equipment to measure how much air leaks into the respirator
 - used on half face respirators, full face respirators and PAPR.

Quantitative fit testing results are more objective than qualitative testing because some workers have difficulty with their ability to taste or smell. This can result in a 'false pass' and worker health not being adequately protected.

It is recommended that full face respirators and PAPR are fit tested using the quantitative method.

All fit testing must be carried out by a competent person, manufacturer, supplier or consultant:

- before a worker wears a tight-fitting respirator for the first time
- each time a new make or model of respirator is provided to a worker, and
- whenever there is a change in the wearer's facial characteristics or features that may affect the seal (e.g. large weight loss or gain).

Fit testing should be repeated on a regular basis and based upon the outcomes of a risk assessment (e.g. every one or two years).

Keep a written record of fit tests carried out for each worker including the:

- type of test performed
- make, model, style and size of respirator tested, and
- date and result of the test.

Issue your workers with a fit test record card after fit testing.

You must provide training for your workers who are provided with RPE. This is to make sure they fit, use and maintain the RPE they are expected to use. Training must be provided by a competent person; this could be a consultant, someone in house or a representative from a RPE manufacturer or supplier.

Good training for RPE should cover:

- why the RPE is required for their job
- when the worker should and must wear the RPE
- how the RPE works
- the limitations of the RPE
- how to correctly put on and take off the RPE
- how to fit check
- how to clean and maintain the RPE
- when and how to replace the filters, and
- how and where to store RPE when not in use.

Figure 11 Respiratory protective equipment



Reusable half-face respirator



Full face respirator (cartridge)



Full face Powered Air Purifying Respirator (PAPR)

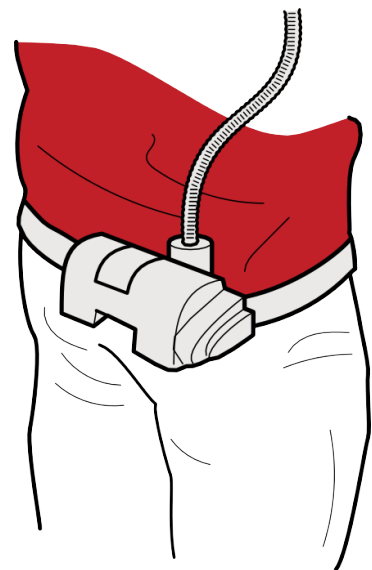

PPE when working with silica containing products

Respiratory protective equipment is not enough to protect your workers from silica dust.

Due to the high levels of silica in composite stone products, a combination of controls are required to protect workers' health including engineering, isolation, work practices, personal protective equipment, worker training and consultation.

It is recommended that for workers using hand held water fed equipment to wear a full face respirator with a P3 class filter or a full face PAPR with a P2 class filter.

Fit testing is essential to make sure the respirator works correctly and is comfortable to wear with any other PPE that may be needed for the task. This may require seeking advice from suppliers or manufacturers.

The PPE you select must also be appropriate for other risks that might arise when working with silica containing products such as:

- eye protection
- aprons, foot wear and gloves
- hard hats, and
- personal hearing protection.

As discussed above, training for workers by a competent person is essential and you should supervise your workers to make sure they understand their training and are using their PPE correctly.

Case study: Stonemason

A stonemason had been regularly working with natural marble and granite products for many years, the granite containing 25 per cent silica.

An occupational hygienist was engaged to measure the worker's exposure levels in the early days of setting up the business. The worker had regular health monitoring, including an x-ray every five years.

Extraction ventilation systems kept exposures at a level under the workplace exposure standard.

The business model changed due to increased industry demand to using engineered stone products that contained more than 90 per cent silica.

When the silica exposure levels were rechecked, the airborne silica levels were above the workplace exposure standard and the control systems in place needed to be modified to bring exposure back under control.

To manage the risk, a system of wet cutting methods and wearing a powered air purifying respirator with a P2 class filter was introduced.

You can find more information on the Safe Work Australia webpage: Personal protective equipment.

4.5. Reviewing your controls

Managing WHS risks is an ongoing process that needs attention over time and particularly when any changes affect the activities carried out at your workplace.

The control measures you put in place should be reviewed regularly to make sure they work as planned. You should review the control measures for high risks more frequently. Don't wait until something goes wrong. A review of your control measures is required:

- when the control measure is not effective in controlling the risk, for example if:
 - a worker's health monitoring report shows an injury, illness or disease
 - the doctor supervising a worker's health monitoring requests a review of your control measures
 - air monitoring shows airborne silica dust is at or above 50 per cent of the workplace exposure standard
- before something significant changes at the workplace, for example there is a change to:
 - the workplace itself
 - any aspect of the work environment, and
 - any system of work, process or procedure
- if a new hazard or risk is identified
- if raised by your workers or HSR during consultation
- if a HSR requests a review, and
- at least once every five years.

To review your control measures you can use the same process as when you are identifying a hazard. Consult with your workers and HSR and consider the following questions:

- Are the control measures working effectively in both their design and operation?
- Have the control measures introduced new problems?
- Have all hazards been identified?
- Have new work methods, new equipment or chemicals made the job safer?
- Are safety procedures being followed?
- Have the instruction and training provided to workers on how to work safely been successful?
- Are workers actively involved in identifying hazards and possible control measures? Are they openly raising health and safety concerns and reporting problems promptly?
- Are the frequency and severity of health and safety incidents reducing over time?
- If new legislation or new information becomes available, does it show that your current controls may no longer be the most effective?

If you find any problems, go back through and review your information and make further decisions about risk control.

4.6. More information:

More information about controlling silica dust at your workplace is available from your [local WHS regulator](#).